

Article number: 209512M1046129ST

Description: E+G Pulling latches for clamps GN 852
GN 951.2-M10-46-129-ST

Measures

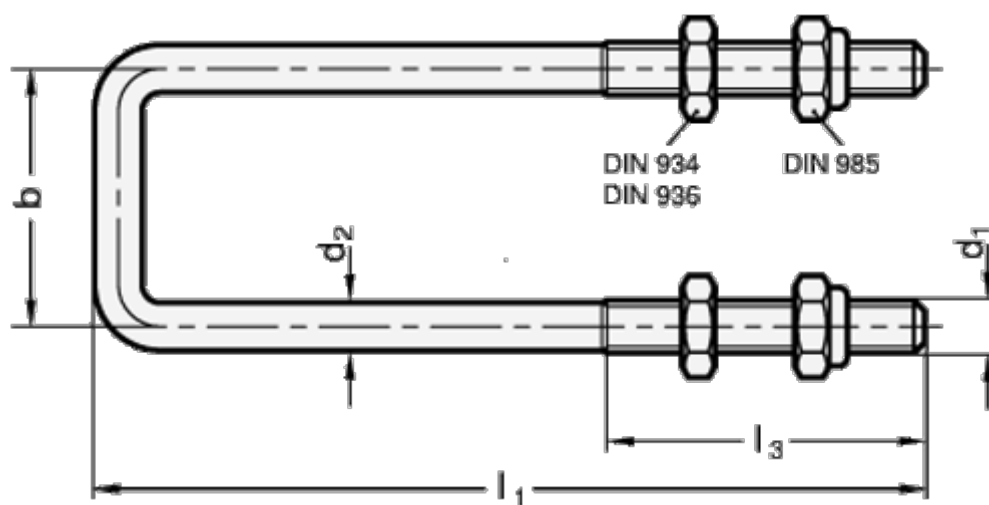

$b = 46$
 $d_1 = M10$
 $d_2 = 9.0$
 $l_1 = 129$
 $l_3 = 45.0$